

THIS DOCUMENT IS THE PROPERTY OF KEYSTONE ELECTRONICS CORP. AND SHALL NOT BE REPRODUCED, DISTRIBUTED OR USED AS A BASIS FOR MANUFACTURE WITHOUT PRIOR WRITTEN PERMISSION FROM KEYSTONE ELECTRONICS CORP.

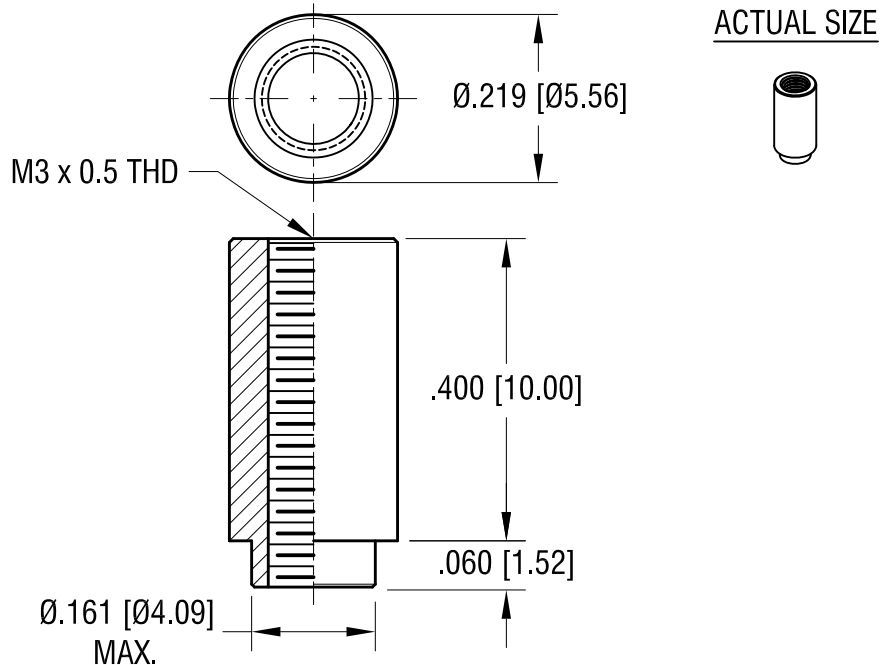
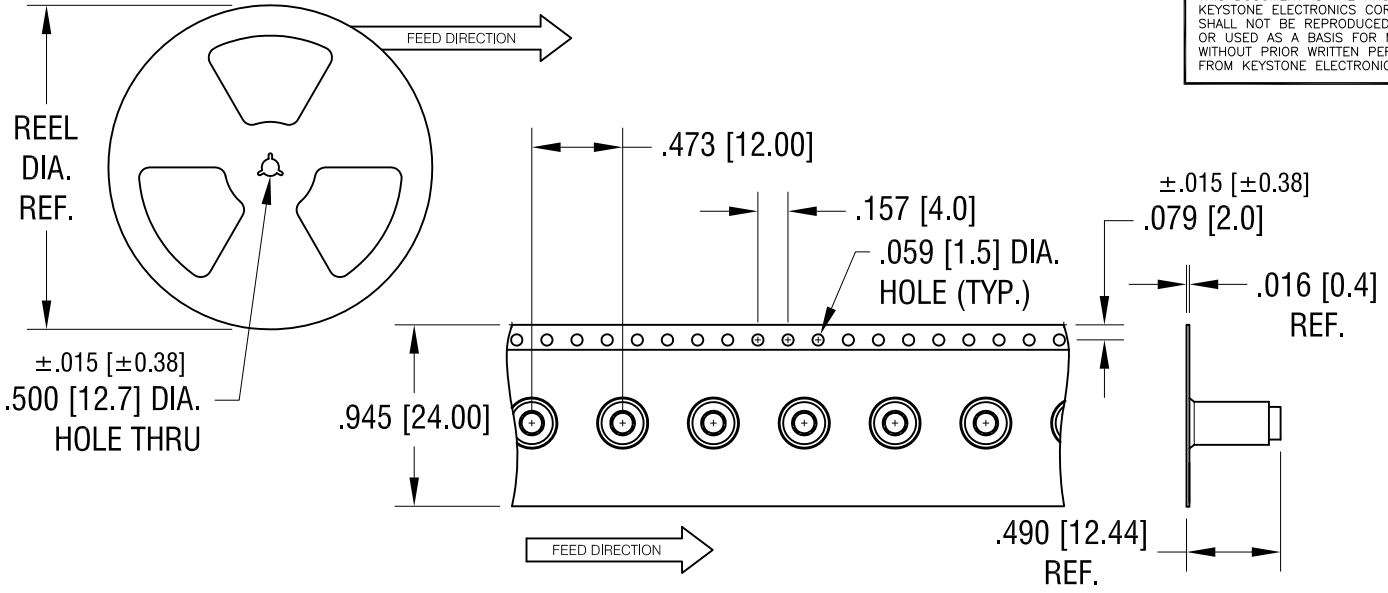

NOTES:

1. SUPPLIED ON TAPE AND REEL ONLY.
TAPE AND REEL SPECIFICATIONS:
2. TAPE:
MAT'L - ALL CONDUCTIVE POLYSTYRENE CARRIER
ANSI/EIA-481 STANDARD
3. REEL:
13" [330.2] DIA. 300 PIECES PER REEL
4. KAPTON TAPE ADDED TO TOP SURFACE
OF STANDOFF

KEYSTONE ELECTRONICS CORP.			
www.keyelco.com • ASTORIA, N.Y. 11105-2017 • Tel (718) 956-8900			
PART NAME		SM STANDOFF	
MATERIAL		STEEL	
FINISH	DRN BY	DATE	
ELECTRO-TIN	NT	11.16.16	
	APP'D	SCALE	
	LN	4X, 1X	
TOLERANCES	INCH	[MM]	CODE
DECIMAL	$\pm .005$	$[\pm 0.13]$	C
ANGULAR	$\pm 1^\circ$		
UNLESS OTHERWISE SPECIFIED			
DWG NO.		24886	

DATE	DESCRIPTION	REV.