

THIS DOCUMENT IS THE PROPERTY OF
KEYSTONE ELECTRONICS CORP. AND
SHALL NOT BE REPRODUCED, DISTRIBUTED
OR USED AS A BASIS FOR MANUFACTURE
WITHOUT PRIOR WRITTEN PERMISSION
FROM KEYSTONE ELECTRONICS CORP.

MOUNTING DETAIL

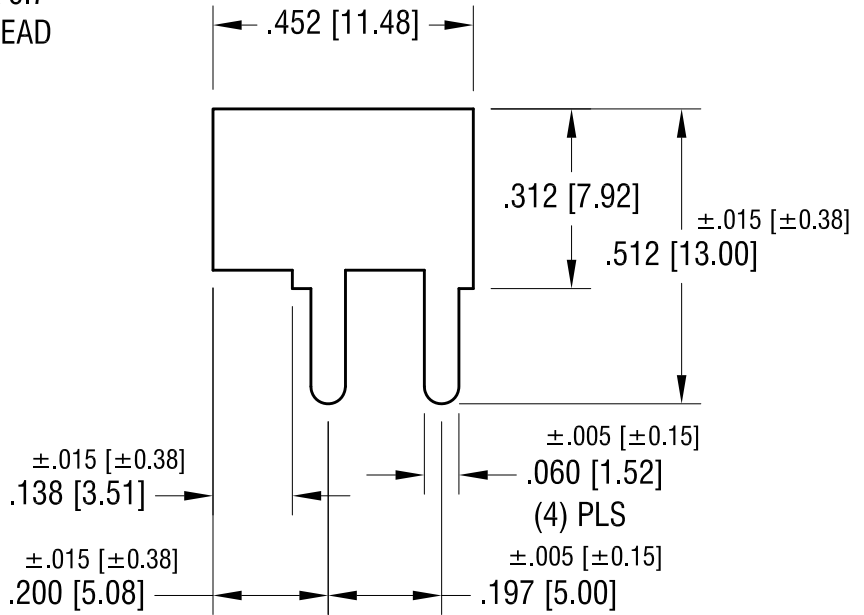
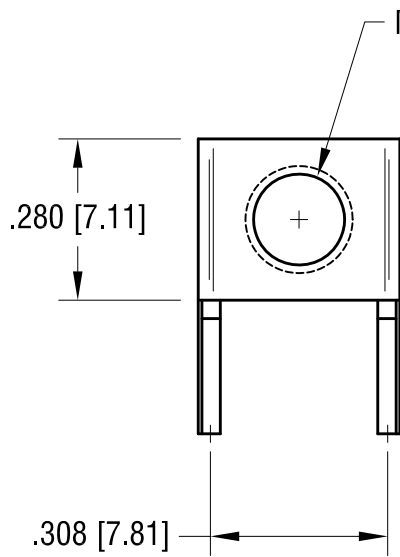
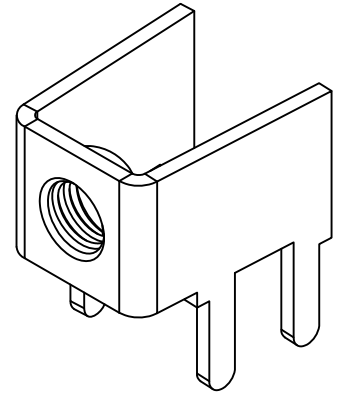
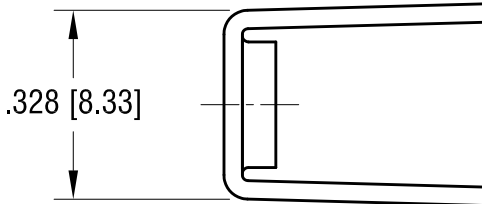
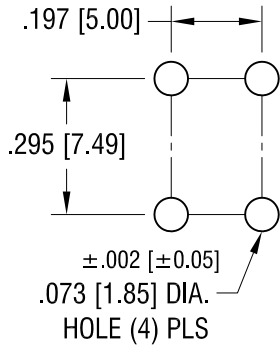

KEYSTONE ELECTRONICS CORP.

www.keyelco.com • ASTORIA, N.Y. 11105-2017 • Tel (718) 956-8900

PART NAME		PC SCREW TERMINAL	
MATERIAL		.032 [0.81] TH'K BRASS	
FINISH	DRN BY	DATE	
MATTE TIN PLATE	NT	4.15.11	
	APP'D	SCALE	
	LN	3X	
TOLERANCES	INCH	[MM]	CODE
DECIMAL	± .010	[± 0.25]	C
ANGULAR	± 1°		
UNLESS OTHERWISE SPECIFIED			DWG NO.
			7764

DATE	DESCRIPTION	REV.